



# H750

# Standing Flower Tower

## Specification

(mm)

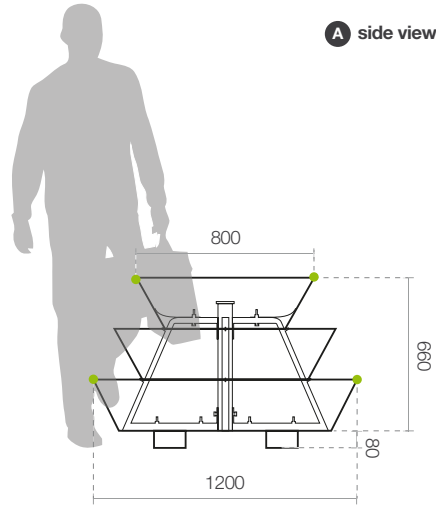

**! Beware of imitations!**

It is impossible to copy quality and safety. Only products branded with Terra's sign can provide the highest quality, safety and accuracy of execution.

Product protected by patent

▼ P 379058

Registered design

▼ Wp 9324-25

Made in EU

36 month warranty

Number of rings	3	Weight before planting	58 kg
Capacity	373 liters	weight after planting	190 - 370 kg
total height	740 mm	Estimated amount of seedlings	40 - 50 pieces
Base diameter	1200 mm	Warranty	36 months

Weight depending on the type of soil and its moisture

**Terra Cascading Flower Towers** include a 3-year warranty program called "DOOR TO DOOR". In practice it is an extensive system of support and technical assistance, as well as an extremely efficient service guarantee. Product's flaws will promptly be fixed by our service team in any place designated or new products will be delivered.

## Colours (DUPLEX)



### DUPLEX System

The combination of a galvanized layer and a polyester powder coat gives an extraordinary resistance. The top coat of paint, which supposed to be a decoration, becomes an additional anticorrosive layer.

## Production method

- laser-cut rings
- MAG / TIG welded rings
- hot dip galvanized
- powder coated rings (DUPLEX system)

## Safety

- rubber gasket on each ring
- no sharp edges
- heavy and stable
- high resistance to vandalism
- can be fixed to the ground



# H750

# Standing Flower Tower

## Transport (mm)

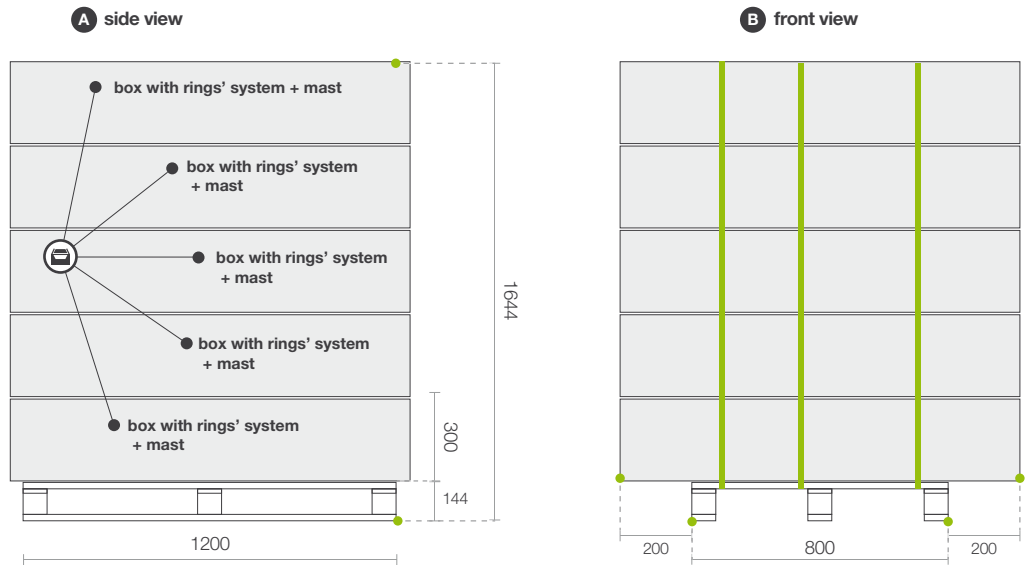

SET PACKED IN A BOX

UP TO **5** SETS FOR A EURO PALLET

## Set content

Lower pan with legs	1 item	Mast	1 item
Rings	2 items	Span	4 items
Screw 10x50	10 items	Security flat bar	2 items
Screw 10x90	4 items	gasket	10 m
		Glue for the gasket	1 item

## Additional accessories

anti-theft system

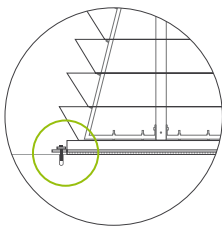

A



side view

B

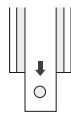

upper view

mobile system

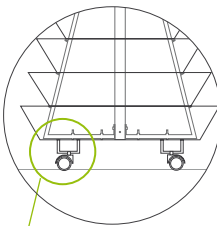

Optional fixing



transport module

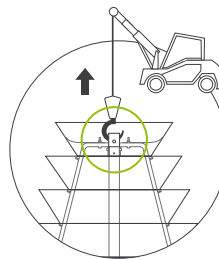

A



front view

B



side view

watering system

**TerraClick Tif**

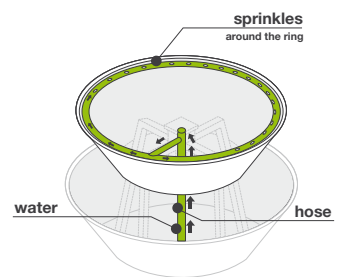

- number of lines in the system: 2
- type of connector: GEKA
- flow of drippers: 2 - 3 l/h
- pressure: 0,5 - 4 atm
- opening pressure of the anti-drip: 0,4 atm
- closing pressure of the anti-drip: 0,2 atm
- hose type: **new generation**  
resistant to chemicals and acidification

